

ACP- GREASE INTERCEPTOR-MODEL GTI-3500

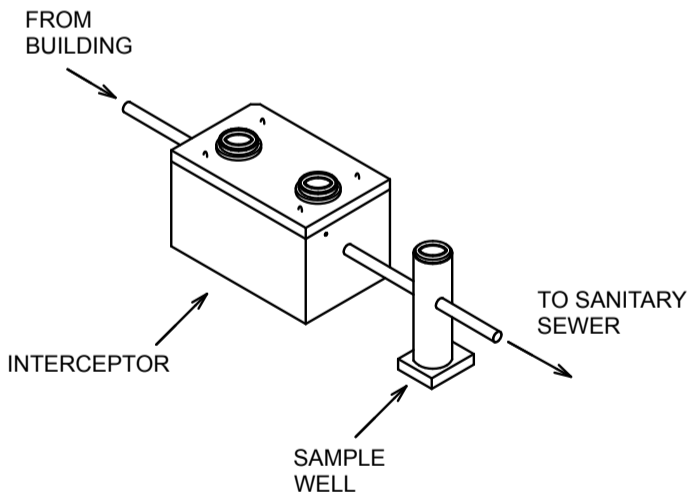
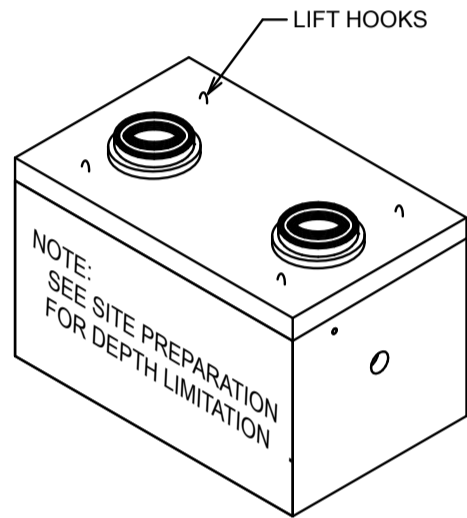
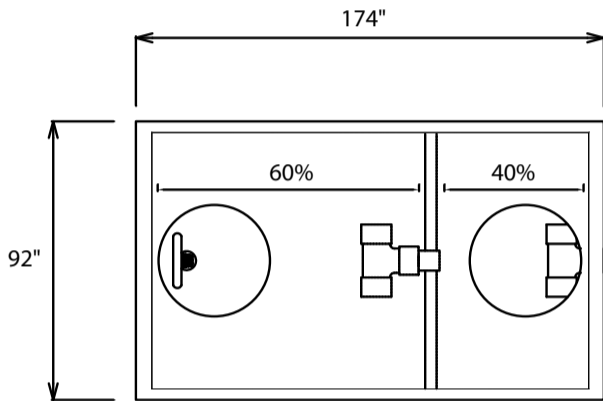
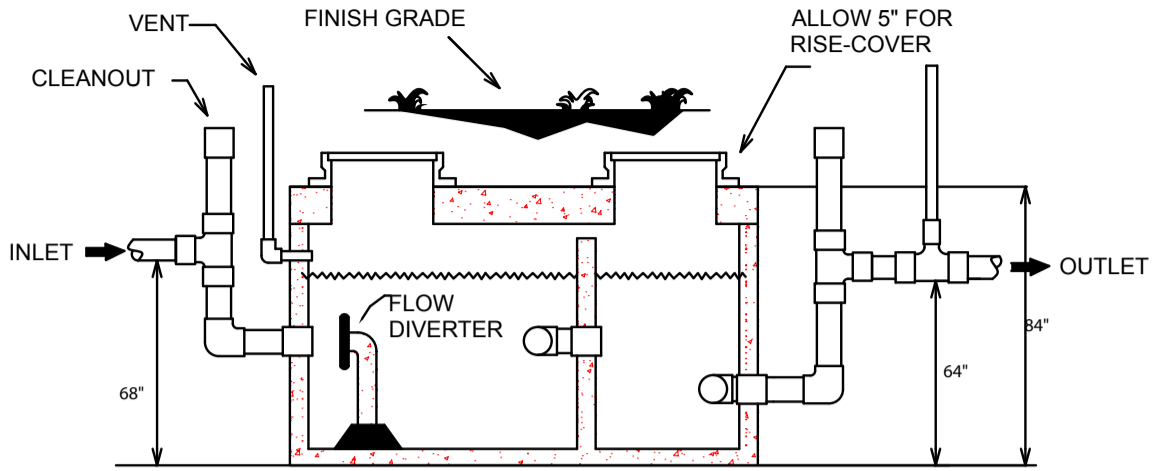

GREASE INTERCEPTOR DIMENSIONS						
MODEL NO. GTI	LENGTH	WIDTH	HEIGHT	INLET	OUTLET	WEIGHT
500 GAL.	76"	68"	50"	36"	33"	9,000LBS
750 GAL.	107"	68"	50"	36"	33"	12,000LBS
1000 GAL.	145"	68"	50"	36"	33"	16,400LBS
1250 GAL.	155"	75"	50"	36"	33"	17,500LBS
1500 GAL.	140"	80"	60"	48"	44"	20,300LBS
2000 GAL.	150"	102"	60"	48"	44"	26,000LBS
2500 GAL.	132"	92"	84"	68"	64"	26,200LBS
3000 GAL.	156"	92"	84"	68"	64"	29,600LBS
3500 GAL.	174"	92"	84"	68"	64"	32,300LBS
4000 GAL.	182"	102"	84"	68"	64"	41,200LBS
4500 GAL.	206"	102"	84"	68"	64"	45,500LBS
5000 GAL.	164"	102"	108"	93"	89"	46,000LBS
5500 GAL.	182"	102"	102"	93"	89"	48,000LBS
6000 GAL.	194"	102"	102"	93"	89"	50,300LBS

LARGER TANKS AVAILABLE UP TO 20,000 GAL.

ACP-2011



**AFFORDABLE
CONCRETE
PRODUCTS INC.**

SPECS FOR:

CITY OF AUSTIN

SCALE:
NONE

MODEL:
GTI-3500

STANDARD SPECIFICATIONS ACP-2011

- *4500 PSI CONCRETE CLASS 1
- *GRADE 60 REINFORCING STEEL
- *8" TRAFFIC LID/H-20 RATED
- *ALLOW 5" RING AND COVER IN TOTAL HEIGHT
- *INLET/OUTLET / 4" SCH40 PVC (6" AVAILABLE)
- *MAXIMUM DEPTH TO BOTTOM OF TANK: 10FT

MAIL:
P.O. BOX 1377
BUDA TEXAS 78610
512-312-2121
FAX: 512-295-5534

SHIP:
600 SOUTH LOOP 4
BUDA TEXAS 78610
512-312-2121
FAX: 512-295-5534

EMAIL: ACP500@aol.com
WEBSITE:
www.affordableconcreteproducts.com

ENGINEERING DATA

- *INTERCEPTOR IS HYDRAULICALLY & STRUCTURALLY ENGINEERED TO CONFORM WITH LOCAL UNIFORM PLUMBING CODE.
- *INTERCEPTOR WILL BE FACTORY ASSEMBLED PRIOR TO DELIVERY.
- *USE DIMENSIONAL DATA AS SHOWN FOR FIELD EXCAVATION.
- *(MUST BE COMPLETE PRIOR TO DELIVERY)

ACP- GREASE INTERCEPTOR-MODEL GTI-3500

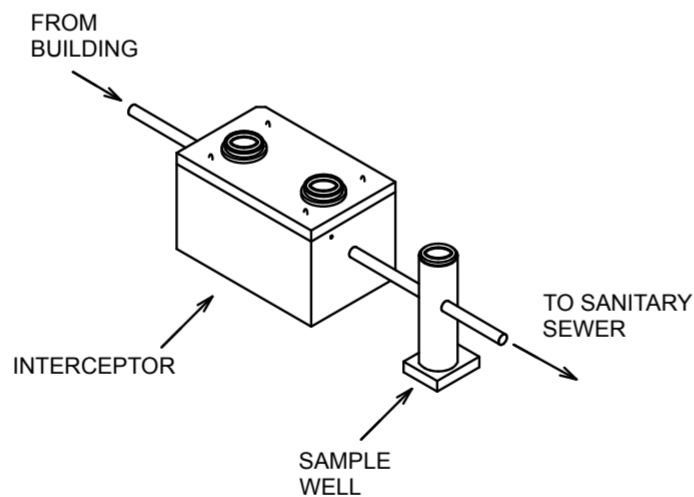
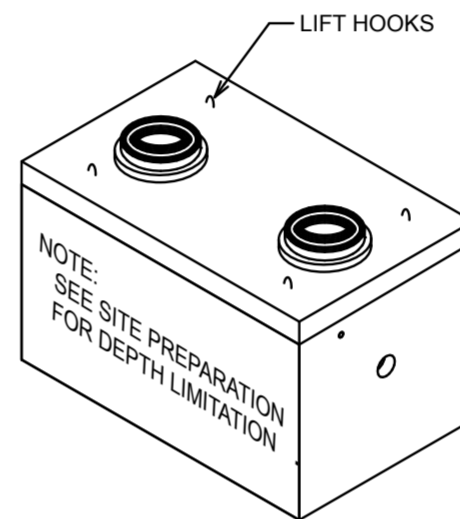
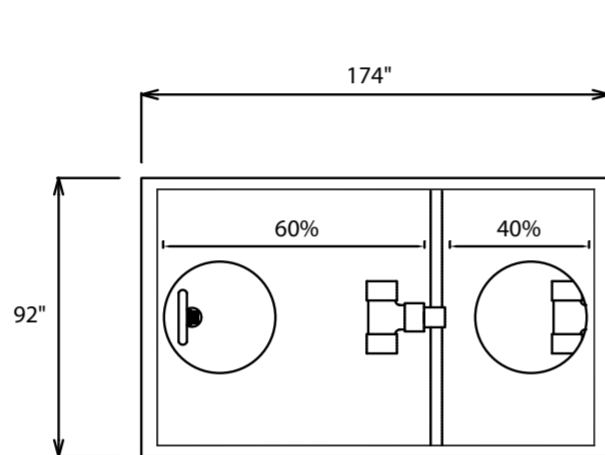
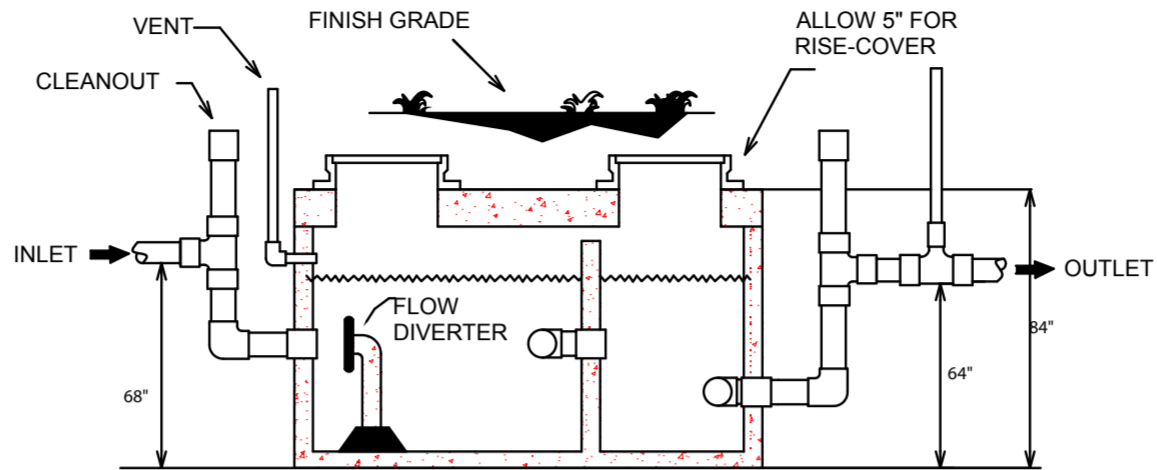

GREASE INTERCEPTOR DIMENSIONS						
MODEL NO. GTI	LENGTH	WIDTH	HEIGHT	INLET	OUTLET	WEIGHT
500 GAL.	76"	68"	50"	36"	33"	9,000LBS
750 GAL.	107"	68"	50"	36"	33"	12,000LBS
1000 GAL.	145"	68"	50"	36"	33"	16,400LBS
1250 GAL.	155"	75"	50"	36"	33"	17,500LBS
1500 GAL.	140"	80"	60"	48"	44"	20,300LBS
2000 GAL.	150"	102"	60"	48"	44"	26,000LBS
2500 GAL.	132"	92"	84"	68"	64"	26,200LBS
3000 GAL.	156"	92"	84"	68"	64"	29,600LBS
3500 GAL.	174"	92"	84"	68"	64"	32,300LBS
4000 GAL.	182"	102"	84"	68"	64"	41,200LBS
4500 GAL.	206"	102"	84"	68"	64"	45,500LBS
5000 GAL.	164"	102"	108"	93"	89"	46,000LBS
5500 GAL.	182"	102"	102"	93"	89"	48,000LBS
6000 GAL.	194"	102"	102"	93"	89"	50,300LBS

LARGER TANKS AVAILABLE UP TO 20,000 GAL.

ACP-2011



**AFFORDABLE
CONCRETE
PRODUCTS INC.**

SPECS FOR:
CITY OF AUSTIN
SCALE: NONE
MODEL: GTI-3500

STANDARD SPECIFICATIONS ACP-2011

- *4500 PSI CONCRETE CLASS 1
- *GRADE 60 REINFORCING STEEL
- *8" TRAFFIC LID/H-20 RATED
- *ALLOW 5" RING AND COVER IN TOTAL HEIGHT
- *INLET/OUTLET / 4" SCH40 PVC (6" AVAILABLE)
- *MAXIMUM DEPTH TO BOTTOM OF TANK: 10FT

ENGINEERING DATA

- *INTERCEPTOR IS HYDRAULICALLY & STRUCTURALLY ENGINEERED TO CONFORM WITH LOCAL UNIFORM PLUMBING CODE.
- *INTERCEPTOR WILL BE FACTORY ASSEMBLED PRIOR TO DELIVERY.
- *USE DIMENSIONAL DATA AS SHOWN FOR FIELD EXCAVATION.
- *(MUST BE COMPLETE PRIOR TO DELIVERY)

MAIL:
P.O. BOX 1377
BUDA TEXAS 78610
512-312-2121
FAX: 512-295-5534

SHIP:
600 SOUTH LOOP 4
BUDA TEXAS 78610
512-312-2121
FAX: 512-295-5534

EMAIL: ACP500@aol.com
WEBSITE:
www.affordableconcreteproducts.com